

Зона	Поз. обозначение	Наименование	Кол.	Примечание																																													
	XP1	BH-40 (Доп.зам.: WE #61204021621 (Wurth Elektronik))	1																																														
	XT1...XT10	MB332-38104 (Deca Switchlab) (Доп.зам.: MKDS1/4-3,81 (Phoenix Contact))	10																																														
<table border="1" style="width:100%; border-collapse: collapse;"> <tr> <td style="width: 20px;"></td> <td style="width: 20px;"></td> <td style="width: 20px;"></td> <td style="width: 20px;"></td> <td style="width: 20px;"></td> <td colspan="3"></td> </tr> <tr> <td>Изм.</td> <td>Лист</td> <td>№ докум.</td> <td>Подп.</td> <td>Дата</td> <td colspan="3"></td> </tr> <tr> <td>Разраб.</td> <td></td> <td></td> <td></td> <td></td> <td>Лист</td> <td>Лист</td> <td>Листов</td> </tr> <tr> <td>Проб.</td> <td></td> <td></td> <td></td> <td></td> <td></td> <td></td> <td>1</td> </tr> <tr> <td>Н.контр.</td> <td></td> <td></td> <td></td> <td></td> <td colspan="3" rowspan="2" style="text-align: center; vertical-align: middle;">Модуль коммутации</td> </tr> <tr> <td>Утв.</td> <td></td> <td></td> <td></td> <td></td> </tr> </table>													Изм.	Лист	№ докум.	Подп.	Дата				Разраб.					Лист	Лист	Листов	Проб.							1	Н.контр.					Модуль коммутации			Утв.				
Изм.	Лист	№ докум.	Подп.	Дата																																													
Разраб.					Лист	Лист	Листов																																										
Проб.							1																																										
Н.контр.					Модуль коммутации																																												
Утв.																																																	

Перв. примен.

Справ. №

Подп. и дата

Инв. № дубл.

Взам. инв. №

Подп. и дата

Инв. № подл.

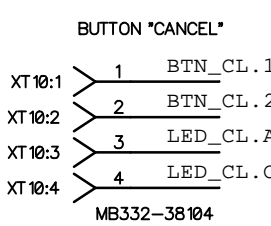
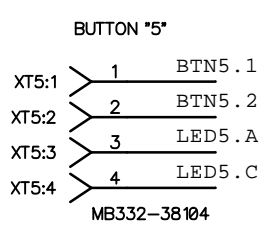
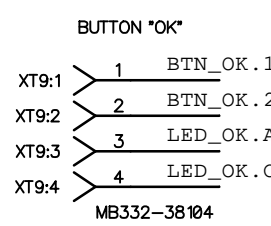
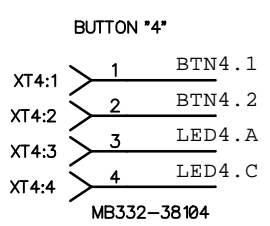
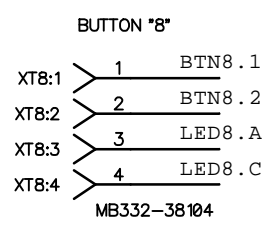
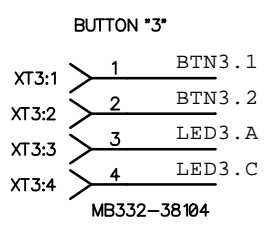
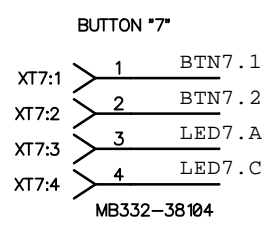
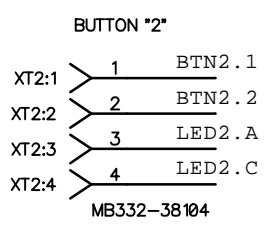
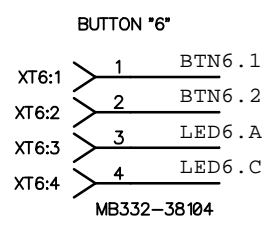
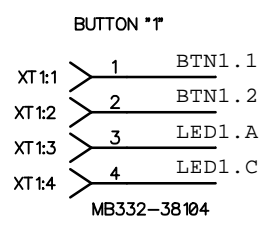

	XP1 BH-40	
	Конт.	Цепь
BTN_OK.1	1	BTN_OK.1
BTN_OK.2	2	BTN_OK.2
LED_OK.A	3	LED_OK.A
LED_OK.C	4	LED_OK.C
BTN1.1	5	BTN1.1
BTN1.2	6	BTN1.2
LED1.A	7	LED1.A
LED1.C	8	LED1.C
BTN2.1	9	BTN2.1
BTN2.2	10	BTN2.2
LED2.A	11	LED2.A
LED2.C	12	LED2.C
BTN3.1	13	BTN3.1
BTN3.2	14	BTN3.2
LED3.A	15	LED3.A
LED3.C	16	LED3.C
BTN4.1	17	BTN4.1
BTN4.2	18	BTN4.2
LED4.A	19	LED4.A
LED4.C	20	LED4.C
BTN5.1	21	BTN5.1
BTN5.2	22	BTN5.2
LED5.A	23	LED5.A
LED5.C	24	LED5.C
BTN6.1	25	BTN6.1
BTN6.2	26	BTN6.2
LED6.A	27	LED6.A
LED6.C	28	LED6.C
BTN_CL.1	29	BTN_CL.1
BTN_CL.2	30	BTN_CL.2
LED_CL.A	31	LED_CL.A
LED_CL.C	32	LED_CL.C
BTN7.1	33	BTN7.1
BTN7.2	34	BTN7.2
LED7.A	35	LED7.A
LED7.C	36	LED7.C
BTN8.1	37	BTN8.1
BTN8.2	38	BTN8.2
LED8.A	39	LED8.A
LED8.C	40	LED8.C

Изм	Лист	№ докум.	Подпись	Дата
Разраб.				(Date)
Пров.				
Т. контр.				
Соглас.				
Н. контр.				
Утв.				

**Модуль коммутации**

Схема электрическая принципиальная

Литера	Масса	Масштаб
Лист 1	Листов 1	

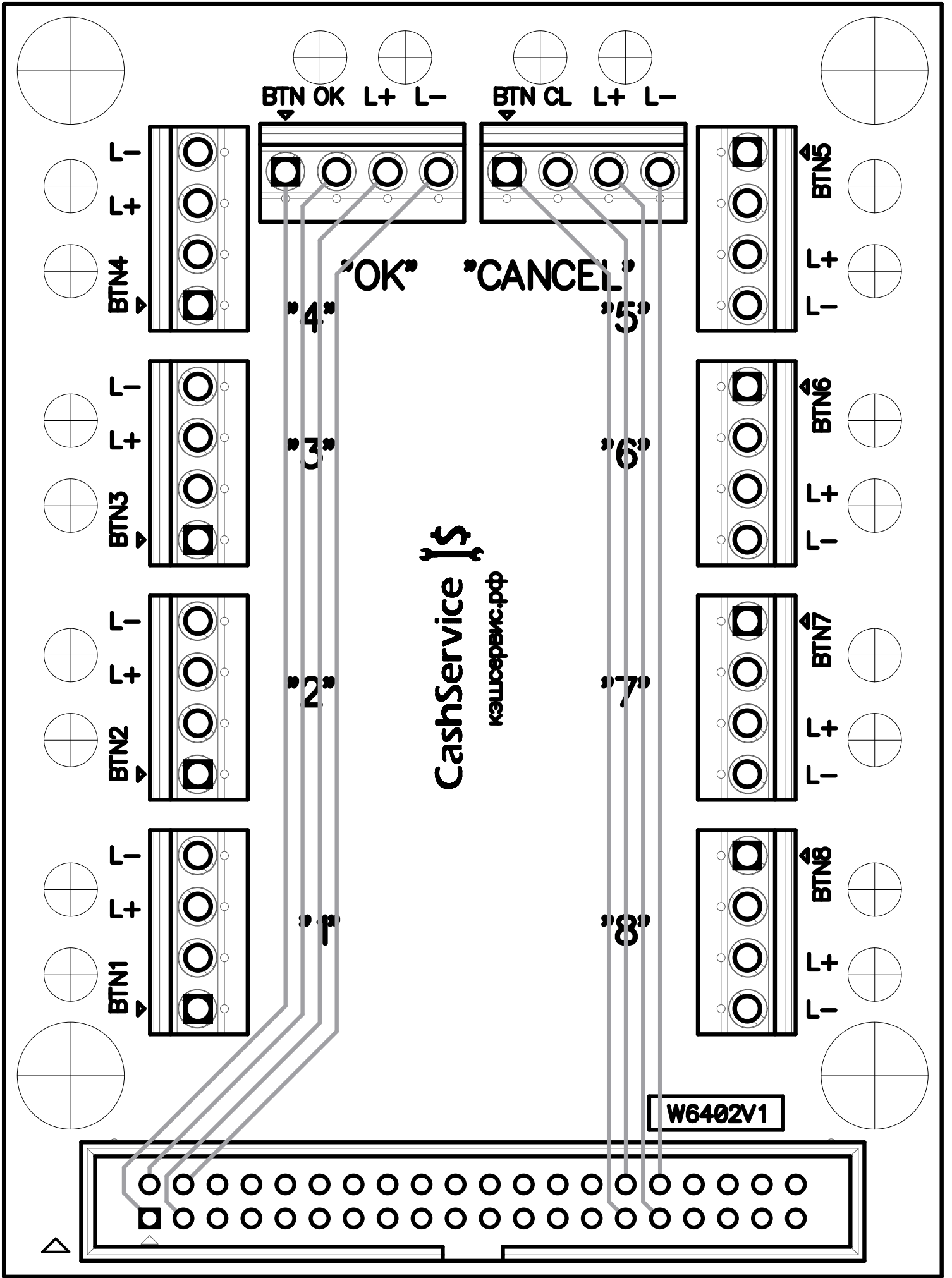

CashService  
калсервис.рф

W6402V1

